



INDUSTRIAL SHIELDS

SPARTAN ARDUINO PLC

PLC ARDUINO

SPARTAN



SPARTAN ARDUINO PLC User Guide

Revised March 2020

This user guide is for version Spartan Arduino PLC, with Reference name Ref. 017001001200 .

Preface

This User Guide is been implemented by Boot & Work, S.L. working under the name Industrial Shields.

Purpose of the manual

The information contained in this manual can be used as a reference to operating, to functions, and to the technical data of the signal modules, power supply modules and interface modules.

Intended Audience

This User Guide is intended for the following audience:

- Persons in charge of introducing automation devices.
- Persons who design automation systems.
- Persons who install or connect automation devices.
- Persons who manage working automation installation.



Warnings:

- Unused pins should not be connected. Ignoring the directive may damage the controller.
- Improper use of this product may severely damage the controller.
- Refer to the controller's User Guide regarding wiring considerations.
- Before using this product, it is the responsibility of the user to read the product's User Guide and all accompanying documentation.
- Maintenance must be performed by qualified personnel familiarized with the construction, operation, and hazards involved with the control.
- Maintenance should be performed with the control out of operation and disconnected from all sources of power.
- Care should be taken when servicing electrostatic sensitive components. The manufacturer's recommendations for these components should be followed.
- The Spartan Arduino PLC is Open Type Controller. It is required that you install the Spartan Arduino PLC in a housing, cabinet, or electric control room. Entry to the

housing, cabinet, or electric control room should be limited to authorized personnel. Failure to follow these installation requirements could result in severe personal injury and/or property damage. Always follow these requirements when Spartan Arduino PLC .

- In case of installation or maintenance of the Spartan PLC please follow the instructions marked in the Installation and Maintenance section.
- Do not disconnect equipment when a flammable or combustible atmosphere is present. Disconnection of equipment when a flammable or combustible atmosphere is present may cause a fire or explosion which could result in death, serious injury and/or property damage.



Avertissements:

- Les broches non utilisées ne doivent pas être connectées. Ignorer la directive peut endommager le contrôleur.
- Une utilisation incorrecte de ce produit peut endommager gravement le contrôleur.
- Reportez-vous au Guide de l'utilisateur du contrôleur pour les considérations de câblage.
- Avant d'utiliser ce produit, il incombe à l'utilisateur de lire le Guide de l'utilisateur du produit et la documentation qui l'accompagne.
- La maintenance doit être effectuée par personnel qualifié familiarisé avec la fabrication, le fonctionnement et les dangers liés au contrôleur.
- La maintenance doit être effectuée avec l'équipement hors service et déconnectée de toutes les sources d'alimentation.
- Faites attention lors de l'entretien des composants sensibles à l'électricité statique. Les recommandations du fabricant pour ces composants doivent être suivies.
- L'automate Spartan Arduino PLC est contrôleur de type ouvert. Il est nécessaire d'installer l'automate Spartan Arduino PLC dans un boîtier, une armoire ou une salle de contrôle électrique. L'accès au boîtier, à l'armoire ou à la salle de commande électrique doit être limité au personnel autorisé. Le non-respect de ces exigences d'installation peut entraîner des blessures graves et/ou des dommages matériels importants. Respectez toujours ces exigences lors de l'installation de l'automate Spartan Arduino PLC.
- En cas d'installation ou de maintenance du Spartan PLC, veuillez suivre les instructions indiquées dans la section Installation et Maintenance.
- Ne débranchez pas l'équipement en présence d'une atmosphère inflammable ou combustible. La déconnexion de l'équipement en présence d'une atmosphère inflammable ou combustible peut provoquer un incendie ou une explosion pouvant entraîner la mort, des blessures graves et/ou des dommages matériels.

Application Considerations and Warranty

Read and Understand this Manual

Please read and understand this manual before using the product. Please consult your comments or questions to Industrial Shields before using the product.

Application Consideration

THE PRODUCTS CONTAINED IN THIS DOCUMENT ARE NOT SAFETY RATED. THEY SHOULD NOT BE RELIED UPON AS A SAFETY COMPONENT OR PROTECTIVE DEVICE FOR ENSURING SAFETY OF PERSONS, AS THEY ARE NOT RATED OR DESIGNED FOR SUCH PURPOSES.

Please know and observe all prohibitions of use applicable to the products.

FOR AN APPLICATION INVOLVING SERIOUS RISK TO LIFE OR PROPERTY WITHOUT ENSURING THAT THE SYSTEM AS A WHOLE HAS BEEN DESIGNED TO ADDRESS THE RISKS, NEVER USE THE INDUSTRIAL SHIELDS PRODUCTS.

NEVER USE THE INDUSTRIAL SHIELDS PRODUCTS BEFORE THEY ARE PROPERLY RATED AND INSTALLED FOR THE INTENDED USE WITHIN THE OVERALL EQUIPMENT OR SYSTEM.

Industrial Shields shall not be responsible for conformity with any codes, regulations or standards that apply to the combination of products in the customer's application or use of the product.

The following are some examples of applications for which particular attention must be given. This is not intended to be an exhaustive list of all possible uses of the products, nor is it intended to imply that the uses may be suitable for the products:

- Systems, machines, and equipment that could present a risk to life or property.
- Nuclear energy control systems, combustion systems, railroad systems, aviation systems, medical equipment, amusement machines, vehicles, safety equipment, and installation subject to separate industry or government regulations.
- Outdoor use, uses involving potential chemical contamination or electrical interference, or conditions or uses not described in this document.

At the customer's request, INDUSTRIAL SHIELDS will provide applicable third party certification documents identifying ratings and limitations of use that apply to the products. This information by itself is not sufficient for a complete determination of the suitability of the products in combination with the system, machine, end product, or other application or use.

Intended use or of Industrial Shields products

Consider the following:

Industrial Shields products should only be used for the cases of application foreseen in the catalogue and the associated technical documentation. If third-party products and components are used, they must have been recommended or approved by Industrial Shields.

The correct and safe operation of the products requires that your transport, storage, installation, assembly, operation and maintenance have been carried out in a correct It must respect the permissible ambient conditions. You should also follow the indications and warnings that appear in the associated documentation.

The product / system dealt with in this documentation should only be handled or manipulated by qualified personnel for the task entrusted and observing what is indicated in the documentation corresponding to it, particularly the safety instructions and warnings included in it. Due to their training and experience, qualified personnel are in a position to recognize risks resulting from the handling or manipulation of such products / systems and to avoid possible hazards.

Disclaimers

Weights and Dimensions

Dimensions and weights are nominal and they are not used for manufacturing purposes, even when tolerances are shown.

Performance Data

The performance data given in this manual is provided as a guide for the user in determining suitability and does not constitute a warranty. It may represent the result of INDUSTRIAL SHIELDS's test conditions, and the users must correlate it to actual application requirements. Actual performance is subject to the INDUSTRIAL SHIELDS Warranty and Limitations of Liability.

Change in Specifications

Product specifications and accessories may be changed at any time based on improvements and other reasons.

It is our practice to change model numbers when features are changed, or published ratings or when significant construction changes are made. However, some specifications of the products may be changed without any notice. When in doubt, special numbers may be assigned to fix or establish key specifications for your application on your request. Please consult with your INDUSTRIAL SHIELDS representative at any time to confirm actual specifications of purchased products.

Errors and Omissions

The information in this document has been carefully checked and is believed to be accurate; however, no responsibility is assumed for clerical, typographical, or proofreading errors, or omissions.

The control and drive components of an Industrial Shields PLC are approved for industrial and commercial use in industrial line supplies. Their use in public line supplies requires a different configuration and/or additional measures. These components may only be operated in closed housings or in higher-level control cabinets with protective covers that are closed, and when all of the protective devices are used. These components may only be handled by qualified and trained technical personnel who are knowledgeable and observe all of the safety information and instructions on the components and in the associated technical user documentation. When carrying out a risk assessment of a machine in accordance with the EU Machinery Directive, the machine manufacturer must consider the following residual risks associated with the control and drive components of a PDS.

1. Unintentional movements of driven machine components during commissioning, operation, maintenance, and repairs caused by, for example: – Hardware defects and/or software errors in the sensors, controllers, actuators, and connection technology – Response times of the controller and drive – Operating and/or ambient conditions not within the scope of the specification – Condensation / conductive contamination – Parameterization, programming, cabling, and installation errors – Use of radio devices / cellular phones in the immediate vicinity of the controller – External influences / damage.
2. Exceptional temperatures as well as emissions of noise, particles, or gas caused by, for example: – Component malfunctions – Software errors – Operating and/or ambient conditions not within the scope of the specification – External influences / damage.
3. Hazardous shock voltages caused by, for example: – Component malfunctions – Influence of electrostatic charging – Induction of voltages in moving motors – Operating and/or ambient conditions not within the scope of the specification – Condensation / conductive contamination – External influences / damage
4. Electrical, magnetic and electromagnetic fields generated in operation that can pose a risk to people with a pacemaker, implants or metal replacement joints, etc. if they are too close.
5. Release of environmental pollutants or emissions as a result of improper operation of the system and/or failure to dispose of components safely and correctly.

Warranty and Limitations of Liability

Warranty

Industrial Shields's exclusive warranty is that the products are free from defects in materials and workmanship for a period of one year (or other period if specified) from date of sale by Industrial Shields.

INDUSTRIAL SHIELDS MAKES NO REPRESENTATION OR WARRANTY, EXPRESSED OR IMPLIED, REGARDING MERCHANTABILITY, NON-INFRINGEMENT, OR FITNESS FOR PARTICULAR PURPOSE OF THE PRODUCTS. ANY BUYER OR USER ACKNOWLEDGES THAT THE BUYER OR USER ALONE HAS DETERMINED THAT THE PRODUCTS WILL SUITABLY MEET THE REQUIREMENTS OF THEIR INTENDED USE. INDUSTRIAL SHIELDS DISCLAIMS ALL OTHER WARRANTIES, EXPRESS OR IMPLIED

Limitations of Liability

INDUSTRIAL SHIELDS SHALL NOT BE RESPONSIBLE FOR SPECIAL, INDIRECT, OR CONSEQUENTIAL DAMAGES, LOSS OF PROFITS OR COMERCIAL LOSS IN ANY WAY CONNECTED WITH THE PRODUCTS, WHETHER SUCH CLAIM IS BASED ON CONTRACT, WARRANTY, NEGLIGENCE, OR STRICT LIABILITY.

IN NO EVENT SHALL INDUSTRIAL SHIELDS BE RESPONSIBLE FOR WARRANTY, REPAIR OR OTHER CLAIMS REGARDING THE PRODUCTS UNLESS INDUSTRIAL SHIELDS'S ANALYSIS CONFIRMS THAT THE PRODUCTS WERE PROPERLY HANDLED, STORED, INSTALLED, AND MAINTAINED AND NOT SUBJECT TO CONTAMINATION, ABUSE, MISUSE, OR INAPPROPIATE MODIFICATION OR REPAIR.

Table of Contents

1.	Spartan Arduino PLC: General Features	10
2.	Technical Specifications.....	11
2.1	General Specifications:	11
2.2	Performance Specification:	11
2.3	Symbology.....	12
3.	Precautions	13
3.1	Arduino Board	13
3.2	Intended Audience	13
3.3	General Precautions	13
4.	Software interface.....	14
5.	How to connect PLC Arduino to PC	17
6.	How to connect PLC to power supply	18
7.	Ardbox Analog I/O pinout:.....	19
7.1	Zone Connections	19
8.	Switch configuration.....	23
8.1	General Switches Configuration	23
8.2	RS- 485 Switch configuration	25
8.3	I2C Switch configuration	25
9.	Ardbox - Arduino I/Os 5V pins	26
9.1	I2C pins – SDA/SCL.....	26
9.1	Pin 2/Pin 3.....	26
10.	I/O technical details	27
11.	Typical Connections.....	30
12.	Connector details	34
13.	Spartan Arduino PLC Dimensions:.....	35
14.	Installation and Maintenance	36
15.	Revision Table	39

1. Spartan Arduino PLC: General Features



Supply Voltage
24 Vcc

I/Os
Digital
Analog
Relay

COMPACT SPARTAN ARDUINO PLC		
Input Voltage	12 to 24Vdc ===	Fuse protection (2.5A) Polarity protection
Input rated voltage	24 Vdc ===	
Rated Power	30 W	
I Max.	1,5A	
Size	100x45x115	
Clock Speed	16MHz	
Flash Memory	32KB of which 4KB are used by bootloader	
SRAM	2.5KB	
EEPROM	1KB	
Communications	I2C -- USB -- RS485 (Half Duplex)-- SPI -- TTL	RS485
TOTAL Input points	8	
TOTAL Output points	8	
An/Dig Input 10bit (0-10Vcc)	0 to 10Vac Input Impedance: 39K Separated PCB ground Rated Voltage: 10Vac 7 to 24Vdc I min: 2 to 12 mA Galvanic Isolation Rated Voltage: 24 Vdc ===	
* Interrupt isolated Input HS (24Vcc)	7 to 24Vdc I min: 2 to 12 mA Galvanic Isolation Rated Voltage: 24Vdc	7 to 24Vdc I min: 3/6 mA Separated PCB ground
Analog Output 8bit (0-10Vcc)	0 to 10Vac I max: 20 mA Separated PCB ground Rated Voltage: 10Vac ===	
Digital Isolated Output (24Vcc)	5 to 24Vdc I max: 70 mA Galvanic Isolation Diode Protected for Relay Rated Voltage: 24Vdc ===	I _{max} 24Vdc: 410 mA
PWM Isolated Output 8bit (24Vcc)	5 to 24Vdc I max: 70 mA Galvanic Isolation Diode Protected for Relay Rated Voltage: 24Vdc ===	PWM Isolated Output 8bit (24Vcc)
Expandability	I2C – RS485(Half Duplex) – SPI – TTL	
Reference	017001001200	

2. Technical Specifications

2.1 General Specifications:







Power supply voltage	DC power supply	12 to 24Vdc 
Operating voltage range	DC power supply	11.4 to 25.4Vdc 
Power consumption	DC power supply	30VAC max.
External power supply	Power supply voltage	24Vdc 
	Power supply output capacity	700 mA
Insulation resistance		20M Ω min. at 500Vdc between the AC terminals and the protective ground terminal.
Dielectric strength		2.300 VAC at 50/ 60 Hz for one minute with a leakage current of 10mA max. Between all the external AC terminals and the protective earth terminal.
Shock resistance		80m/s ² in the X, Y and Z direction 2 times each.
Ambient temperature (operating)		0° to 60°C
Ambient humidity (operating)		10% to 90% (no condensation)
Ambient environment (operating)		With no corrosive gas
Ambient temperature (storage)		-20° to 60°C
Power supply holding time		2ms min.
Weight		350g max.

2.2 Performance Specification:

Arduino Board	ARDUINO LEONARDO
Control method	Stored program method
I/O control method	Combination of the cyclic scan and immediate refresh processing methods.
Programming language	Arduino IDE. Based on wiring (Wiring is an Open Source electronics platform composed of a programming language. "similar to the C". http://arduino.cc/en/Tutorial/HomePage)
Microcontroller	ATmega32u4
Flash Memory	32KB of which 4KB are used by bootloader
Program capacity (SRAM)	2.5KB
EEPROM	1KB
Clock Speed	16MHz

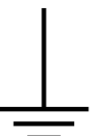
2.3 Symbology

Table that includes all the symbology that is used in the serigraph of the Spartan Arduino PLC :

Symbol	Standard No. / Standard Title	Standard Reference No. / Symbol Title	Symbol Meaning
	IEC 60417 / Graphical symbols for use on equipment	5031 / Direct Current	Indicates that the equipment is suitable for direct current only; to identify relevant terminals
	IEC 60417 / Graphical symbols for use on equipment	5032 / Alternating Current	Indicates that the equipment is suitable for alternating current only; to identify relevant terminals
	IEC 60417 / Graphical symbols for use on equipment	5130 / Pulse General	To identify the control by which a pulse is started.
	IEC 60417 / Graphical symbols for use on equipment	5017 / Earth, Ground	To identify an earth (ground) terminal in cases where neither the symbol 5018 nor 5019 is explicitly required.
	IEC 60417 / Graphical symbols for use on equipment	5115 / Signal lamp	To identify the switch by means of which the signal lamp(s) is (are) switched on or off.
	Medical Devices Directive 93/42/EEC	CE Marking	CE marking indicates that a product complies with applicable European Union regulations
	ISO 7000/ Graphical symbols for use on equipment	0434B / Warning symbol	Indicates a potentially hazardous situation which, if not avoided, could result in death or serious injury
	ISO 7000/ Graphical symbols for use on equipment	5036 / Dangerous Voltage	To indicate hazards arising from dangerous voltages

3. Precautions

Read this manual before attempting to use the Spartan Arduino PLC and follow its descriptions for reference during operation.

3.1 Arduino Board

The Spartan Arduino PLC include Arduino Leonardo Board as controller.

3.2 Intended Audience

This manual is intended for technicians, which must have knowledge on electrical systems.

3.3 General Precautions

The user must operate Spartan Arduino PLC according to the performance specifications described in this manual.

Before using Spartan Arduino PLC under different conditions from what has been specified in this manual or integrating Spartan Arduino PLC to nuclear control systems, railroad systems, aviation systems, vehicles, combustion systems, medical equipment, amusement machines, safety equipment and other systems, machines, and equipment that may have a serious influence on lives and property if used improperly, consult your INDUSTRIAL SHIELDS representative. Ensure that the rating and performance characteristics of Spartan Arduino PLC are sufficient for the systems, machines, and equipment, and be sure to provide the systems, machines, and equipment double safety mechanisms. This manual provides information for programming and operating the Spartan Arduino PLC.

4. Software interface

Industrial Shields PLC are programmed using Arduino IDE, which is a software based on the C language. They can also be programmed using directly C but it is much easier working with Arduino IDE as it provides lots of libraries that helps in the programming.

Furthermore Industrial Shields provides boards for programming the PLCs much easier. Basically it is no needed to define the pins and if that pins are inputs or outputs. Everything is set up automatically if using the boards.

In order to install Industrial Shields boards, these are the steps that must be followed.

Requirements:

Arduino IDE 1.8.0 or above (better to have always the latest version).

Steps:

1. Open Arduino IDE and go to: "File -> Preferences" located in the top left corner.

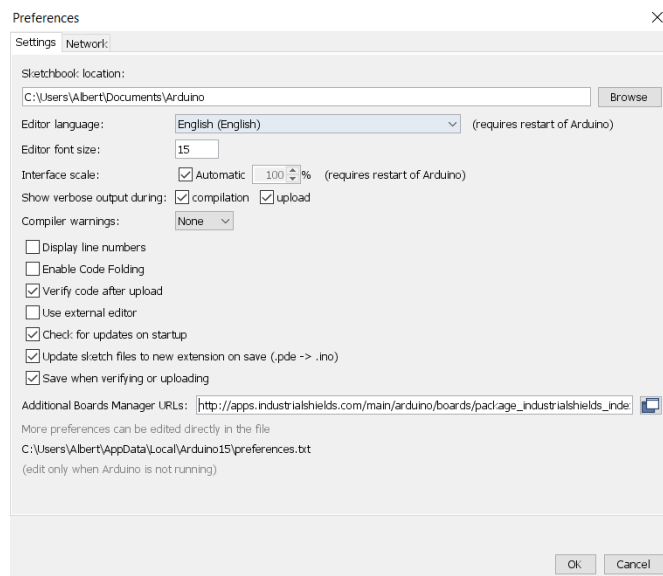

2. In Additional Boards URLs write the following:

http://apps.industrialshields.com/main/arduino/boards/package_industrialshields_index.json

3. Press OK to save the changes.

4. Go to: Tools -> Board: ... -> Boards Manager

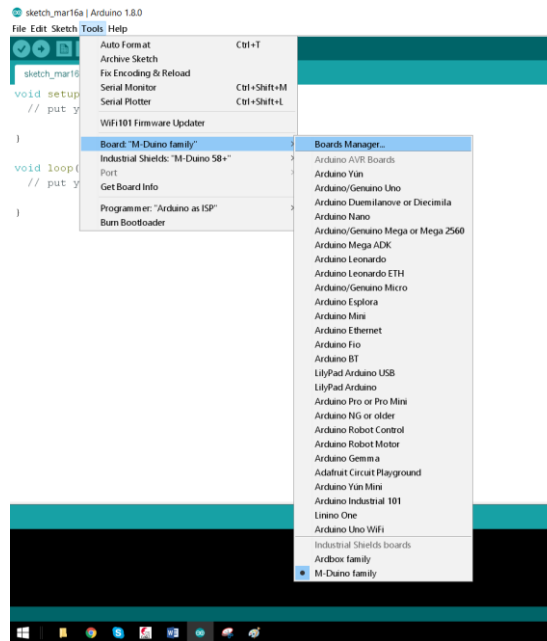

5. Search for industrialshields.

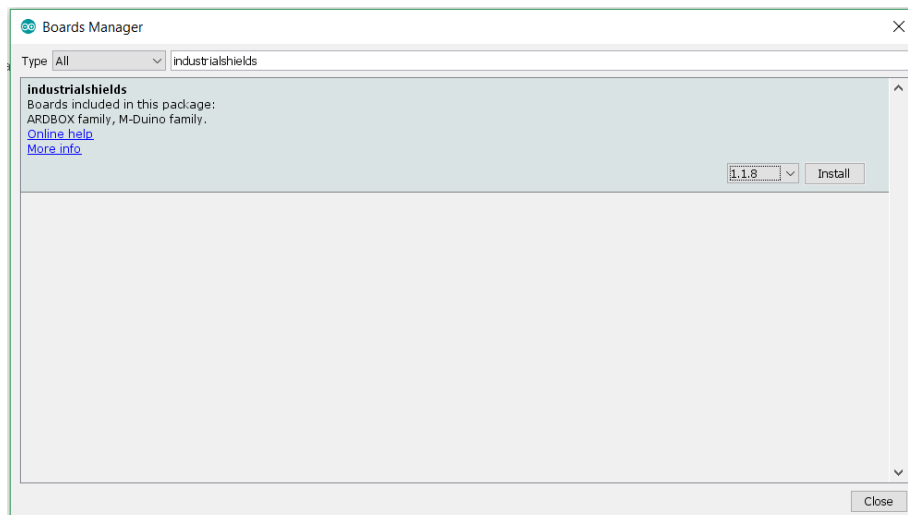

6. Click install (selecting the latest version).

Following this steps you will be able to use now the Industrial Shields Boards:

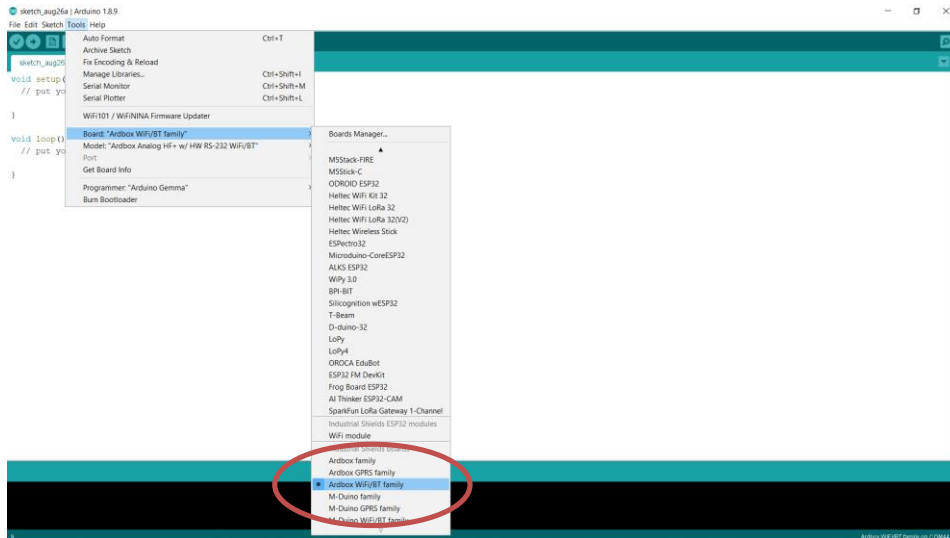

Also there are some examples of programming in File -> Examples -> Spartan Arduino PLC.

Furthermore there are some extra libraries that can be found in Industrial Shields github.

<https://github.com/IndustrialShields/>

5. How to connect PLC Arduino to PC

- Connect USB port from PLC to PC.

NOTE:

Ardbox Family uses micro USB cable.



- Open Arduino IDE interface:
- Select Industrial Shields boards -> Spartan Arduino PLC
- Select correct port.

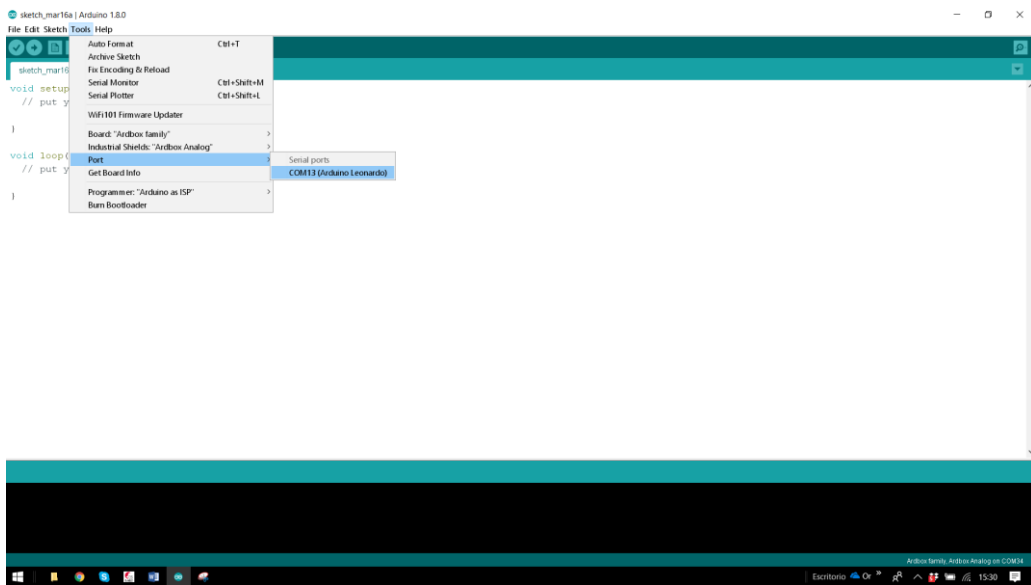

6. How to connect PLC to power supply

- Spartan Arduino PLC 12-24Vdc supplied. **IMPORTANT: The polarity IS NOT REVERSAL!**
- Make sure that the live and GND connector of the power supply match the PLC.
- Make sure that the power supply mains output is not higher than 24Vdc.

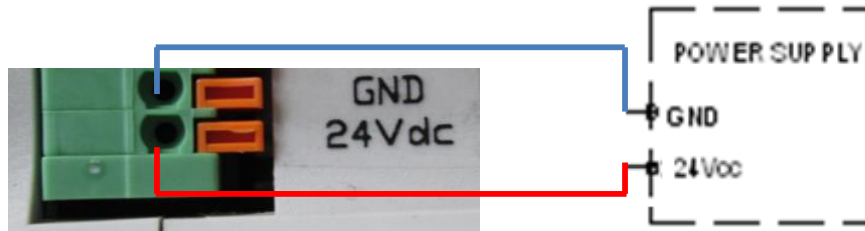

- Suggested power suppliers

Compact DIN rail power supply. Assembled on 35mm
DIN Rail:
-12Vdc / 24Vdc
-2.5A
-30W

Industrial Shields power supplies provide parallel operation, overvoltage protection, and overcurrent protection. There is a LED indicator for power status, the power supply is certified according to UL.



The standard, Part 1 of IEC 61010, sets the general safety requirements for the following types of electrical devices and their accessories, regardless of where use of the device is intended.

The equipment must be powered from an external power source in accordance with IEC 61010-1, whose output is MBTS and is limited in power according to section 9.4 of IEC 61010-1.

WARNING: Once the equipment is installed inside an electrical cabinet, the MTBS cables of the equipment must be separated from the dangerous voltage cables.

7. Ardbox Analog I/O pinout:

7.1 Zone Connections

LEFT ZONE		
Ardbox Connector	Arduino Pin	Function
A0.6 ¹	3	Analog Out
A0.5 ¹	5	Analog Out
A0.4 ¹	6	Analog Out
A0.3 ¹	9	Analog Out
A0.2 ¹	10	Analog Out
A0.1 ¹	11	Analog Out
A0.0 ¹	13	Analog Out
Q0.9 ²	1	Digital Output
Q0.8 ²	0	Digital Output
Q0.7	7	Digital Output
Q0.6 ¹	3	PWM/digital Output
Q0.5	5	PWM/digital Output
Q0.4	6	PWM/digital Output
Q0.3	9	PWM/digital Output
NC	-	Not Connected
NC	-	Not Connected
Q0.0	13	PWM/digital Output
GNDCOM	-	GND
24VCOM	-	Power Supply

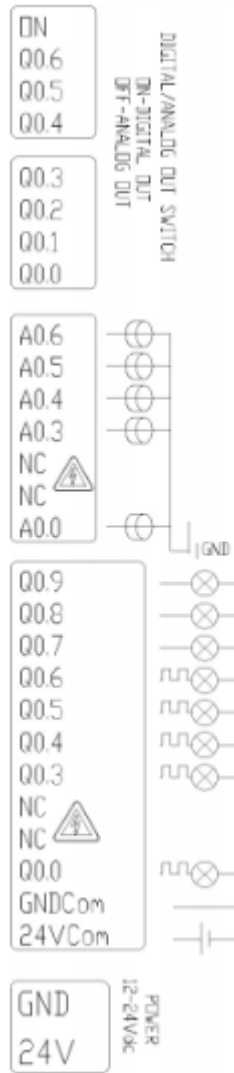

LEFT ZONE

Switch config*

(see section 8 for Communications configuration. Enabling Communications disables some I/Os)

Analog Outputs pins

Digital Outputs pins

Power supply connectors (24Vdc – GND)

RIGHT ZONE			
Ardbox Connector	Arduino Pin	Arduino Pin RS485 HS*	Function
A+ ^{1,2}	-	-	RS485(A)
B- ^{1,2}	-	-	RS485(B)
NC	-	-	Not Connected
NC	-	-	Not Connected
SCL-PIN3 ¹	3	3	SCL(I2C)
SDA-PIN2 ¹	2	2	SDA(I2C)
NC	-	4	Not Connected
NC	-	8	Not Connected
5V	-	-	5Vout DC
RESET	-	-	RESET
SCK	-	-	SPI
MOSI	-	-	SPI
MISO	-	-	SPI
I0.7	18	18	Analog/Digital Input
I0.6	19	19	Analog/Digital Input
I0.5	20	20	Analog/Digital Input
I0.4	21	21	Analog/Digital Input
I0.3	22	22	Analog/Digital Input
I0.2	23	23	Analog/Digital Input
NC	-	-	Not Connected
NC	-	-	Not Connected
I0.1	12	12	Digital Input
I0.0 ¹	2	2	Digital interrupt

¹ See section 8 to enable these connections

² See section 9 to enable these connections

RIGHT ZONE

Switch config*
 (see section 8 for Communications configuration. Enabling Communications disables some I/Os)

Communications pins

Digital/Analog Inputs



LEFT ZONE

Switch config*
 (see section 8 for Communications configuration. Enabling Communications disables some I/Os)

Communications pins

Digital/Analog Inputs

HS*: Hardware Serial

SS*: Software Serial

¹ See section 8 to enable these connections

² See section 9 to enable these connections

NOTE: These Pins are not connected.

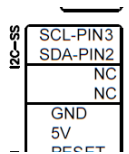

DEFAULT SERIGRAPHY	CORRECT SERIGRAPHY
SDA-PIN2	SDA-PIN2
NC	NC
NC	NC
GND	GND



Industrial Shields
 Spartan Arduino PLC
 Ref: 017001001200
 Analog Input (0-5Vdc)
 Digital Input (0-5Vdc)
 Analog Output (0-10Vdc)
 Digital Output (0-24Vdc)
 www.industrialshields.com

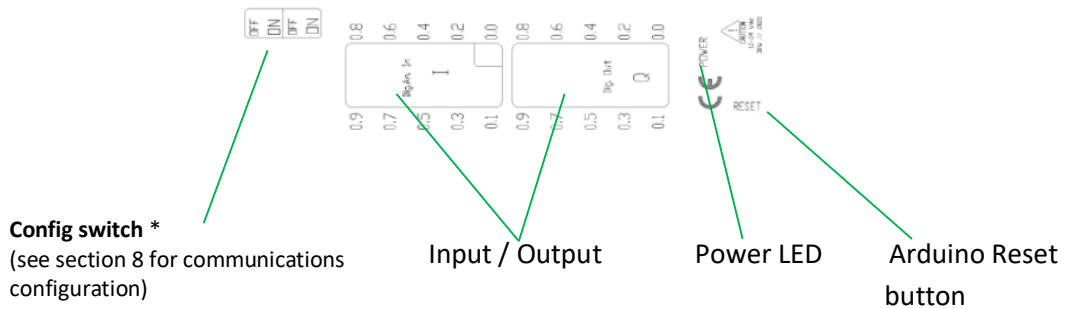

8. Switch configuration

8.1 General Switches Configuration

LEFT ZONE.

Communications and inputs/outputs can not work simultaneously.

LEFT ZONE		
SWITCH	OFF	ON
ON	-	SELECT
OFF	SELECT	-
ON	-	SELECT
OFF	SELECT	-
SDA-D2/I0.0*	SDA-D2	I0.0
SCL-D3/Q0.6*	SCL-D3	Q0.6

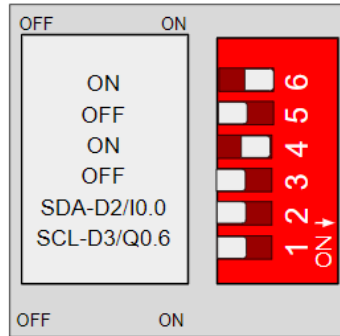

6. Always at ON position.

5. Always at OFF position.

4. Always at ON position.

3. Always at OFF position.

2. SDA-D2/I0.0 – Choosing between SDA (I2C) / Pin2 and I0.0. If this switch is ON, the I0.0 input will be enabled and the SDA / Pin3 will be disabled. If this switch is OFF, the SDA / Pin2 will be now available and I0.0 disabled.

1. SCL-D3/Q0.6 – Choosing between SCL (I2C) / Pin3 and Q0.6. If this switch is ON, the Q0.6 input will be enabled and the SCL / Pin3 will be disabled. If this switch is OFF, the SCL / Pin3 will be now available and Q0.6 disabled.

TOP ZONE

Note: Don't change the switch position

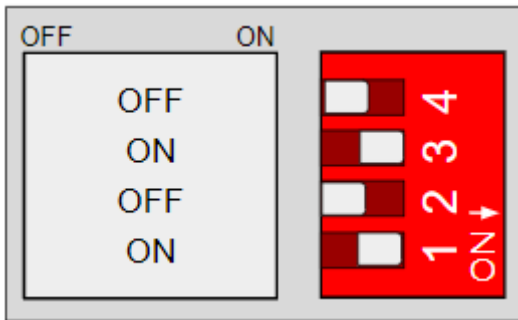

- 4. Always in OFF position.
- 3. Always in ON position.
- 2. Always in OFF position.
- 1. Always in ON position.

RIGHT ZONE SWITCH

In function of the switch position you can select for ON Digital Output and for OFF Analog Output.

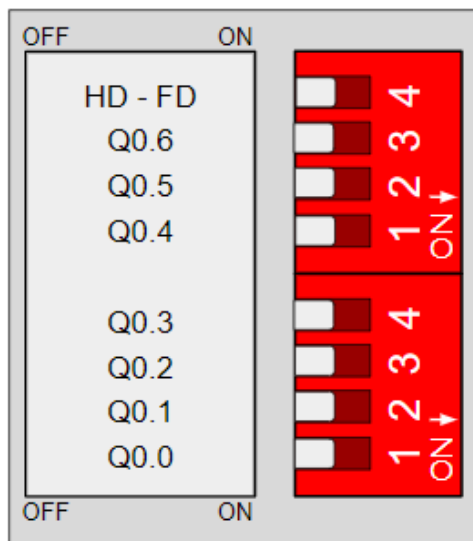

- 4. Always in OFF position.
- 3. Always in OFF position.
- 2. Always in OFF position.
- 1. Always in OFF position.

- 4. Always in OFF position.
- 3. Not Connected.
- 2. Not Connected.
- 1. Always in OFF position.

8.2 RS-485 Switch configuration

TOP ZONE
MODE
OFF
ON
OFF
ON

RS-485 TOP ZONE: In order to enable the RS-485 protocol the TOP ZONE must be configured as it is shown in the table.
Although the switch serigraphy is only referenced to RS-485.

LEFT ZONE
SWITCH CONFIGURATION
MODE
ON
OFF
ON
OFF
-
-

RS-485 LEFT ZONE: In order to enable the RS-485 communication protocol it is necessary that the switches of the left zone are configured as it is showed in the table.

The ones marked with “-“ mean that they don’t affect the RS-485 communication protocol

8.3 I2C Switch configuration

TOP ZONE	
SWITCH	MODE
Q0.8	-
RS485/RS232 HS (RO)	-
Q0.9	-
RS485/RS232 HS (DI)	-

LEFT ZONE	
SWITCH	MODE
RS-485 DE	-
D18 / I0.9	-
RS-485 RE	-
D19 / I0.8	-
SDA-D2/I0.0	OFF
SCL-D3/Q0.6	OFF

I2C: Enable SCL and SDA connections (direct Arduino pins) with configuration switches. I0.0 and Q0.6 will not be available. In order to implement this communication a 4.7kΩ pull-up resistor ([IS.AC12C-4.7K](#)) is required.

9. Ardbox - Arduino I/Os 5V pins

The Ardbox has some of the Leonardo board pins available. These pins can be programmed according to Arduino features such as I/Os operating at 5V or any additional features present in the pins (for example I2C communication in pins SCL and SDA). As this pins are directly connected to the Arduino Leonardo board they are not as well protect as the normal inputs. These pins are mainly meant to be used as prototyping.

Ardbox terminal	Arduino pin
SCL – Pin 3	3
SDA – Pin 2	2
MISO	14
SCK	15
MOSI	16

***IMPORTANT:** Do not connect the terminals in the chart above to voltages higher than 5V. These terminals provide direct access to the Leonardo board.

A part from the switch configuration there are some special conditions depending on these 5V. Now it is going to be shown the considerations to operate with these pins.

9.1 I2C pins – SDA/SCL

The I2C protocol is meant to work in a pull-up configuration. The I2C pins in the Arduino Leonardo are not pull-up, so in order to work with the I2C an external pull-up resistor is required. If it is meant to work as a GPIO at 5V, the switches must be set as I2C, (section 8).

These pins are not established with a pull-up or a pull-down configuration. The state of these pins is unknown. If these pins must be used they require a pull-up or a pull-down configuration. The Arduino board allows the pins to be set in a pull-up configuration. If not it must be established an external pull-up or pull-down circuit in order to correctly work with these pins.

9.1 Pin 2/Pin 3

These pins are only referred to the inputs I0.5/I0.6. If the switch configuration is in OFF position the pins Pin 2/Pin 3 will be available.

These pins are not established with a pull-up or a pull-down configuration. The state of these pins is unknown. If these pins must be used, they require a pull-up or a pull-down configuration. The Arduino board allows the pins to be set in a pull-up configuration. If not it

must be established an external pull-up or pull-down circuit in order to correctly work with these pins.

10. I/O technical details

Digital Output Waveform

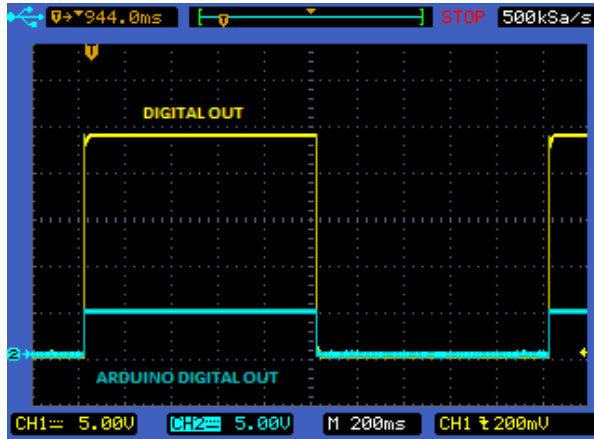

Digital Output Turn-off

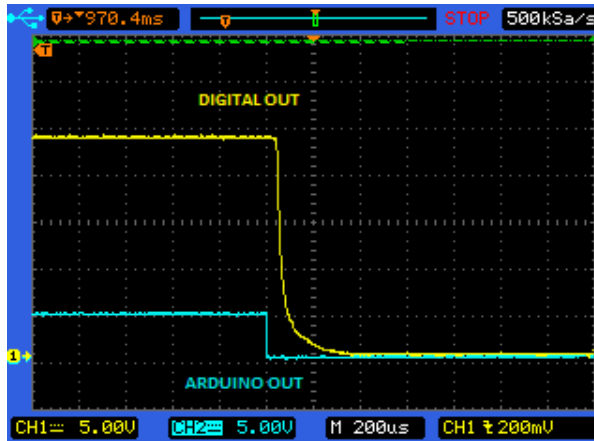

PWM Waveform

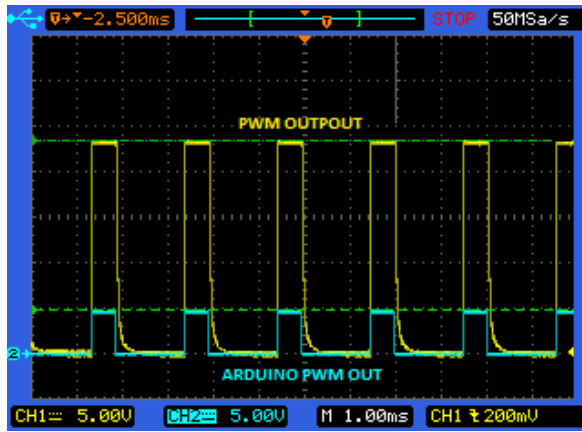

Analog Out Turn-on

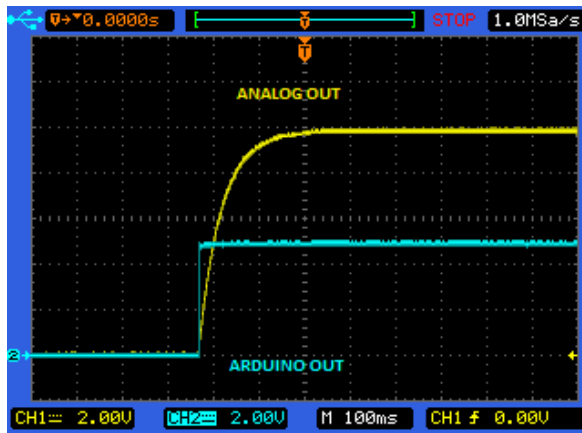

Analog Out Turn-off

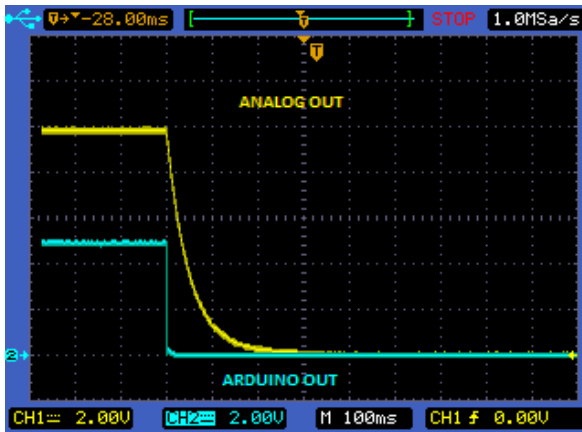

Analog/Digital Input Turn-on

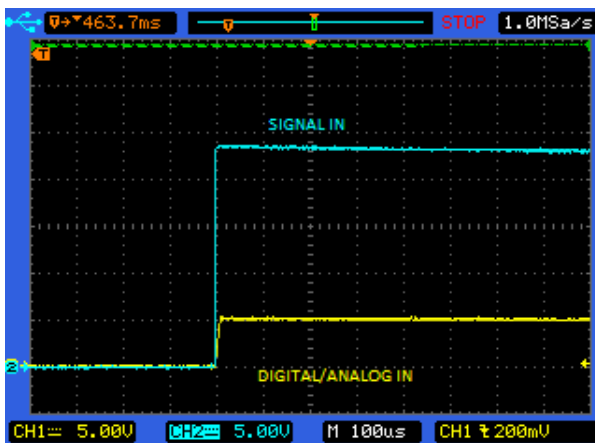

Analog/Digital Input Turn-off

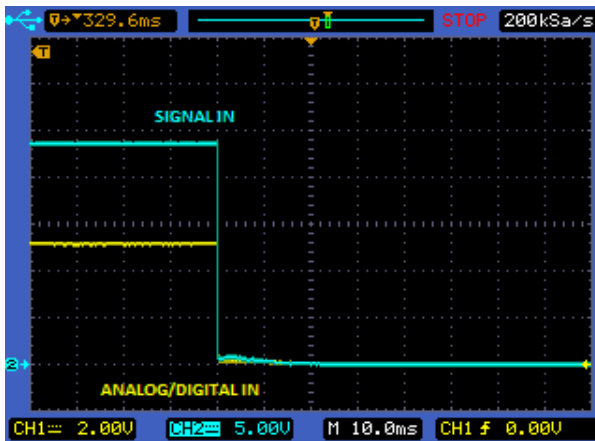

11. Typical Connections

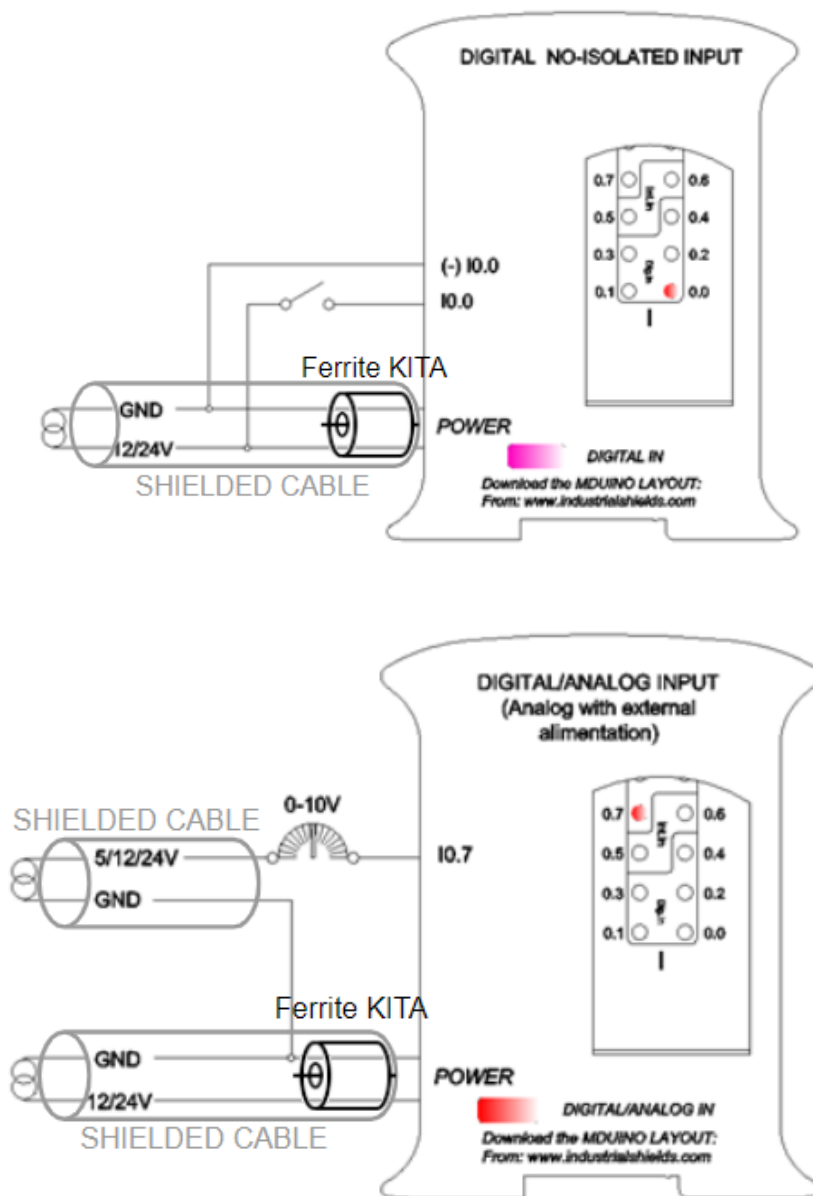

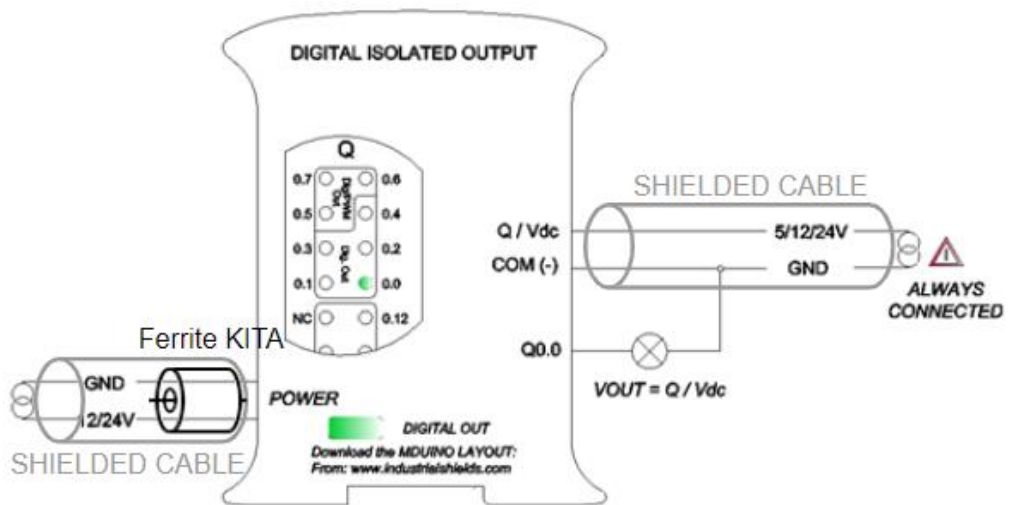
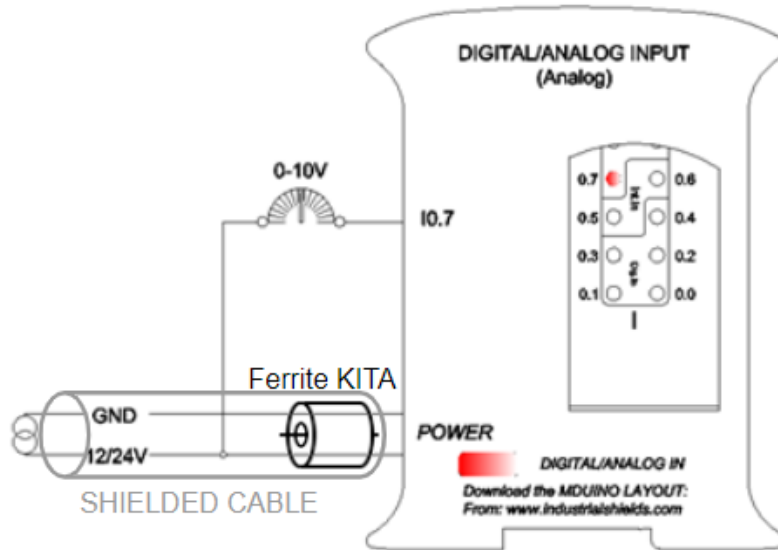

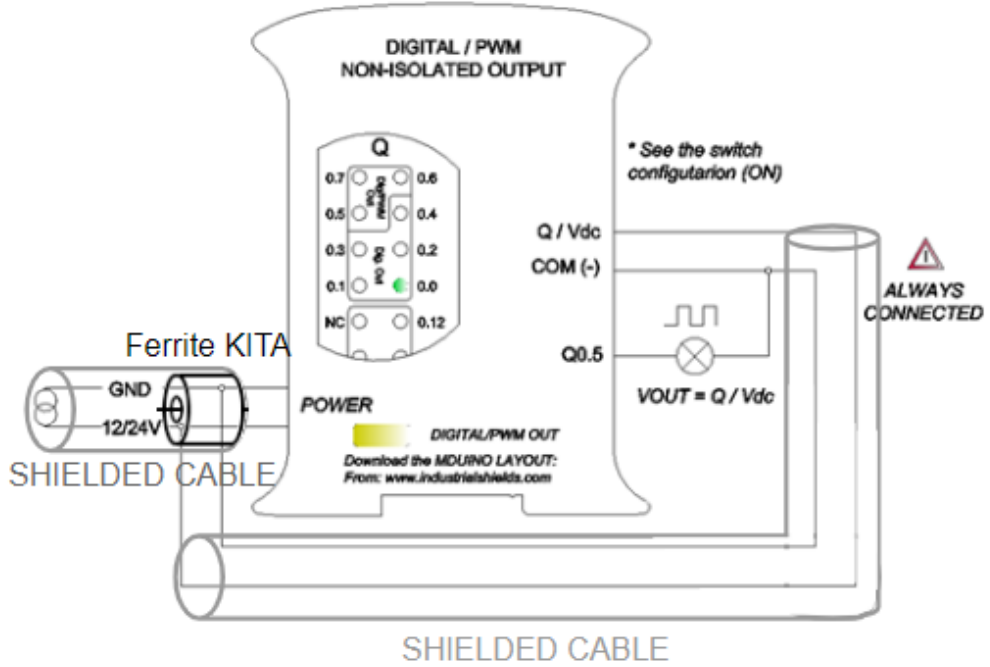
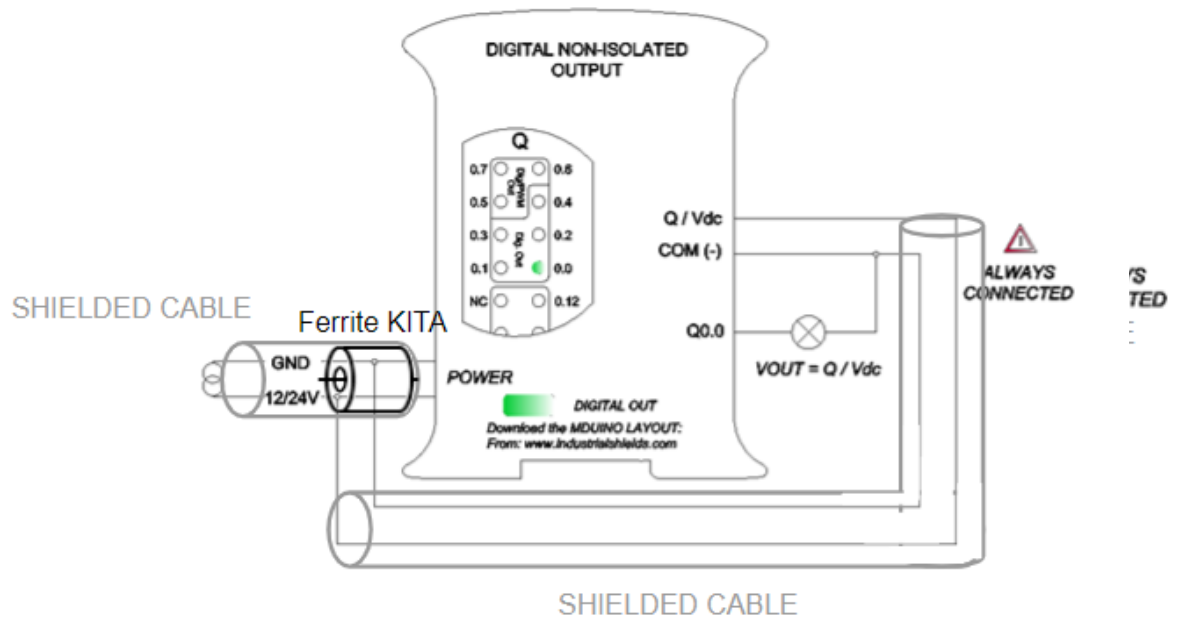

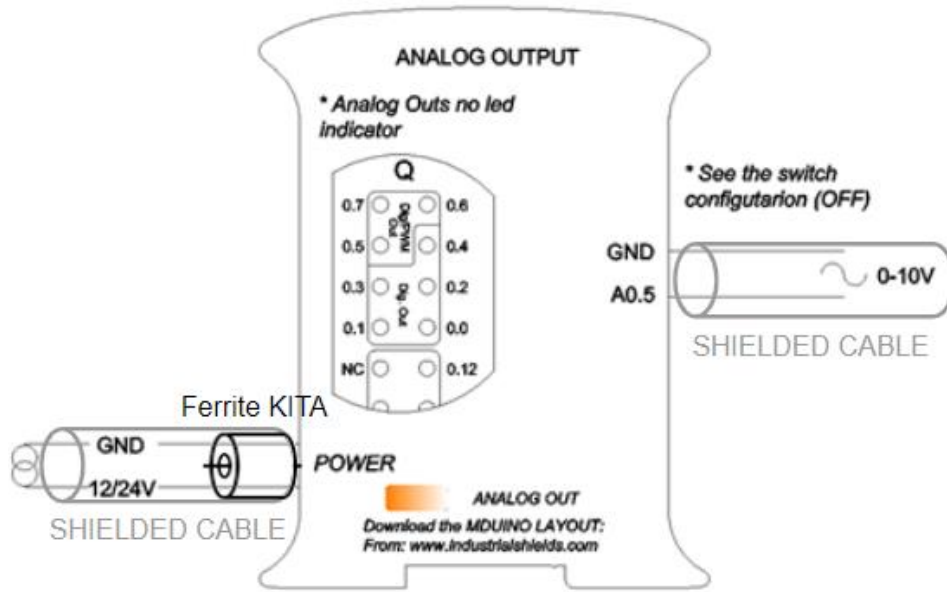

12. Connector details

The connector inside the PLCs that mounts on the PCB is MC 0,5/10-G-2,5 THT – 1963502 from Phoenix contact. MC0,5/10-G-2,5THT

For I/O and power supply there is a FK-MC 0,5/10-ST-2,5 - 1881406 connector from Phoenix contact. FK-MC 0,5/10-ST-2,5

Connection details:

Article reference	MC 0,5/10-G-2,5 THT
Height	8,1mm
Pitch	2,5mm
Dimension	22,5mm
Pin dimensions	0,8x0,8mm
Pin spacing	2,50mm



Article reference	FK-MC 0,5/10-ST-2,5
Rigid conduit section min.	0,14 mm ²
Rigid conduit section max.	0,5 mm ²
Flexible conduit section min.	0,14 mm ²
Flexible conduit section max.	0,5 mm ²
Conduit section AWG/kcmil min.	26
Conduit section AWG/kcmil max.	20

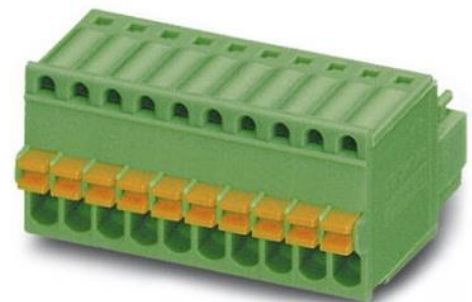

13. Spartan Arduino PLC Dimensions:

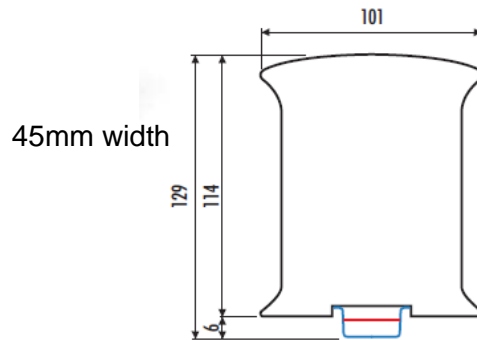

- DIN rail mounting:

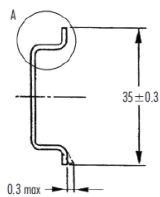
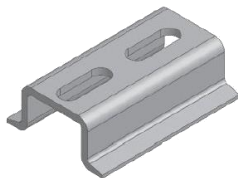

Profilato a cappello TH 35-7,5
Top hat rail TH 35-7,5

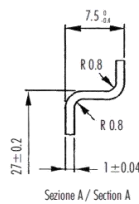

Profilato a cappello TH 35-15
Top hat rail TH 35-15

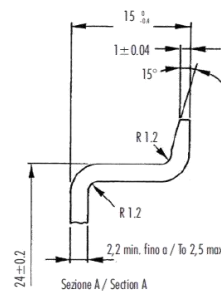

CARATTERISTICHE	METODO	UNITA' DI MISURA	BLENDE PC/ABS
Mecchaniche	Resistenza a trazione allo snervamento	ASTM D638	MPa 48
	Resistenza a trazione a rottura	ASTM D638	MPa 48
	Allungamento a rottura	ASTM D638	% 59
	Modulo in flessione	ASTM D790	MPa 2894
	Prova Izod con intaglio	ISO 180/14	KJ/m ² 5.5
Termiche	Temp. di ammorbidimento Visc. metodo B	ASTM D1525	°C 114
	Temperature Ricotta 1.81 MPa	ASTM D648	°C 97
Fisiche	Pesa specifica	ASTM D792	gr/cm ³ 1.21
	Ritiro sullo stampo	ASTM D955	% 0.4/0.6
	Melt Flow Index 260°C - 98N	ASTM D1238	gr/10' 11.1
Comportamento alla fiamma	Autosostentimento (mm di spessore)	0L94	V-0 (0.8)
	Filo Incandescente 3.2 mm	IEC 695.2.1	°C 960

Italtronic si riserva il diritto di modificare il materiale con cui realizza i propri prodotti senza obbligo di preavviso.

FEATURES	TEST METHOD	UNITS	BLENDE PC/ABS
Mechanical test	Resistance to tensile stress at yield	ASTM D638	MPa 48
	Tensile strength	ASTM D638	MPa 48
	Ultimate elongation	ASTM D638	% 59
	Flexing modulus	ASTM D790	MPa 2894
	Izod test method	ISO 180/14	KJ/m ² 5.5
Thermal test	Softening temperature method B	ASTM D1525	°C 114
	Reheating temperature 1.81 MPa	ASTM D648	°C 97
Physical test	Specific gravity	ASTM D792	gr/cm ³ 1.21
	Mold shrinkage	ASTM D955	% 0.4/0.6
	Melt Flow Index 260°C - 98N	ASTM D1238	gr/10' 11.1
Flame test	Self extinguish (thickness in mm)	0L94	V-0 (0.8)
	Incandescent thread 3.2 mm	IEC 695.2.1	°C 960

Italtronic can operate any change of the materials without being obliged to forewarn.

14. Installation and Maintenance

Notes for installation:

- The installation position should be free from the following: dust or oil smoke, conductive dust, corrosive or flammable gas, high temperature, condensation, and rain.
- Besides, vibration and impact also affect the PLC normal operation and shorten its lifespan; electric shock, fire or misact also damages the product. During drilling or wiring, prevent the metal particles or wire segments from falling into the PLC casing, which may cause fire, fault or misact.
- After the PLC installation, clean the ventilation duct to prevent blocking, which may cause bad ventilation, or even fire, faults or misact.
- Do not online connect, plug or unplug cables, which is apt to cause electric shock or damage the circuit. Installation and wire connection must be firm and reliable. Poor connection could cause misact.
- Use shielded twisted pair for the I/O of high frequency signal and analog signal to improve system IMS.

The installation environment should be free from dust, oil smoke, conductive particle, corrosive or flammable gases, high temperature, condensation, and rain.

Besides, vibration and impact also affect the PLC normal operation and shorten its lifespan. It is recommended to install the PLC, together with the matching switches and contactors, in a dedicated electric cabinet and keep the cabinet ventilated. If the location has high ambient temperature or heat generating equipment nearby, install forced convection devices on top or sides of the cabinet to avoid over-temperature. During drilling or wiring, prevent the metal particles or wire segments from falling into the PLC casing, which may cause fire, fault or misact. After the PLC installation, clean the ventilation duct to prevent blocking, which may cause bad ventilation, or even fire, faults or misact.

The only way to disconnect the equipment from the electrical network is by removing the connectors that feed the equipment. Once installed in the electrical cabinet it is very important to ensure the power connectors for proper operation.

Separate the Spartan Arduino PLC from heat, high voltage and electrical noise:

Always separate the devices that generate high voltage and high electrical noise from the Spartan Arduino PLC. When configuring the layout of the Spartan Arduino PLC inside your panel, consider the heat-generating devices and locate the electronic-type devices in the cooler areas of your cabinet. Reducing the exposure to a high-temperature environment will extend the operating life of any electronic device. Consider also the routing of the wiring for the devices in the electric cabinet. Avoid placing low-voltage signal wires and communications cables in the same tray with AC power wiring and high energy, rapidly-switched DC wiring.

Provide adequate clearance for cooling and wiring Spartan Arduino PLC. Is designed for natural convection cooling. For proper cooling, you must provide a clearance of at least 25 cm above and below the devices. Also, allow at least 25 cm of depth between the front of the modules and the inside of the enclosure.

Notes for maintenance:

A well-planned and executed maintenance program is essential to the satisfactory operation of solid-state electrical equipment. The kind and frequency of the maintenance operation will vary with the kind and complexity of the equipment as well as with the nature of the operating conditions. Maintenance recommendations of the manufacturer or appropriate product standards should be followed.

The following factors should be considered when formulating a maintenance program:

- Maintenance must be performed by qualified personnel familiar with the construction, operation, and hazards involved with the control.
- Maintenance should be performed with the control out of operation and disconnected from all sources of power.
- Care should be taken when servicing electrostatic sensitive components. The manufacturer's recommendations for these components should be followed.
- Ventilation passages should be kept open. If the equipment depends upon auxiliary cooling, e.g., air, water, or oil, periodic inspection (with filter replacement when necessary) should be made of these systems.
- The means employed for grounding or insulating the equipment from ground should be checked to assure its integrity.
- Accumulations of dust and dirt on all parts, including on semiconductor heat sinks, should be removed according to the manufacturer's instructions, if provided; otherwise, the manufacturer should be consulted. Care must be taken to avoid damaging any delicate components and to avoid displacing dust, dirt, or debris in a way that permits it to enter or settle into parts of the control equipment.
- Enclosures should be inspected for evidence of deterioration. Accumulated dust and dirt should be removed from the top of the enclosures before opening doors or removing covers.
- Certain hazardous materials removed as part of maintenance or repair procedure (e.g., polychlorinated biphenyls (PCBs) found in some liquid filled capacitors) must be disposed of as described in Federal regulations.

Safety rules for maintenance personnel

Consider the following steps to follow. A false manoeuvre could be the cause of an accident or material damage.

Do not disassemble or modify the modules. This could lead to breakdowns or malfunctions and could lead to injuries or fire.

- All types of radio communication devices, including mobile phones and personal handy-phone systems (PHS), must be kept more than **25cm** away from the PLC in all directions. Failure to observe this precaution exposes malfunctions caused by excess of temperature.

- Disconnect the external power supply of the system (on all phases) before connecting or disconnecting a module. Failure to observe this precaution may cause faults or malfunctions of the module.
- Tighten the screws of the terminal ports and the screws of the connectors within the prescribed tightening torque. Insufficient tightening can lead to loose parts or wires and cause malfunctions. Excessive tightening can damage the screws and / or the module, with the risk of falling, short circuits and malfunctions.
- Before handling a module, dispose of the electrostatic charge accumulated by the human body by touching a suitable conductive object. Failure to observe this precaution may cause faults or malfunctions of the module.

Repair note:

If the equipment is suitable to be repaired, it must be verified that the equipment remains in a safe state after repair.

15. Revision Table

Revision Number	Date	Changes
0	18 / 03 / 2020	It was first implemented

About Industrial Shields:

Direction: Fàbrica del Pont, 1-11

Zip/Postal Code: 08272

City: Sant Fruitós de Bages (Barcelona)

Country: Spain

Telephone: (+34) 938 760 191 / (+34) 635 693 611

Mail: industrialshields@industrialshields.com