



Software Operation Manual for DM805-AI

Leadshine reserves the right to make changes without further notice to any products herein to improve reliability, function or design. Leadshine does not assume any liability arising out of the application or use of any product or circuit described herein; neither does it convey any license under its patent rights of others.

Leadshine's general policy does not recommend the use of its products in life support or aircraft applications wherein a failure or malfunction of the product may directly threaten life or injury. According to Leadshine's terms and conditions of sales, the user of Leadshine's products in life support or aircraft applications assumes all risks of such use and indemnifies Leadshine against all damages.

©2011 by Leadshine Technology, All Rights Reserved

Change Log

| Revision Date | Changes | Version |
|---------------|-----------------|----------------------|
| 2011-8-26 | Original Create | SM-DM805AI-R20110826 |

Table of Contents

| | |
|--|----|
| Introduction | 1 |
| Workspace | 1 |
| Menus and Toolbar | 1 |
| Using the Software | 2 |
| Opening a file Command | 2 |
| Save as a file Command | 2 |
| Connecting to Drive Window | 3 |
| Current loop tuning Window | 3 |
| Property Window..... | 5 |
| Offset..... | 7 |
| Save to Drive Command | 7 |
| Restore Factory Setting Command..... | 7 |
| Configuring the drive | 7 |
| Set motor related parameters | 8 |
| Tune the current loop..... | 9 |
| Anti-resonance Tuning | 13 |
| Adjusting the Electronic Damping | 14 |
| Contact Us..... | 15 |

Introduction

The ProTuner for DM805-AI is a software tool designed to configure and tune the Leadshine digital drive DM805-AI. The user can tune the current loop and adjust the anti-resonance parameters in this software.

Workspace

After installing the software and open it, the software is displayed as follows.

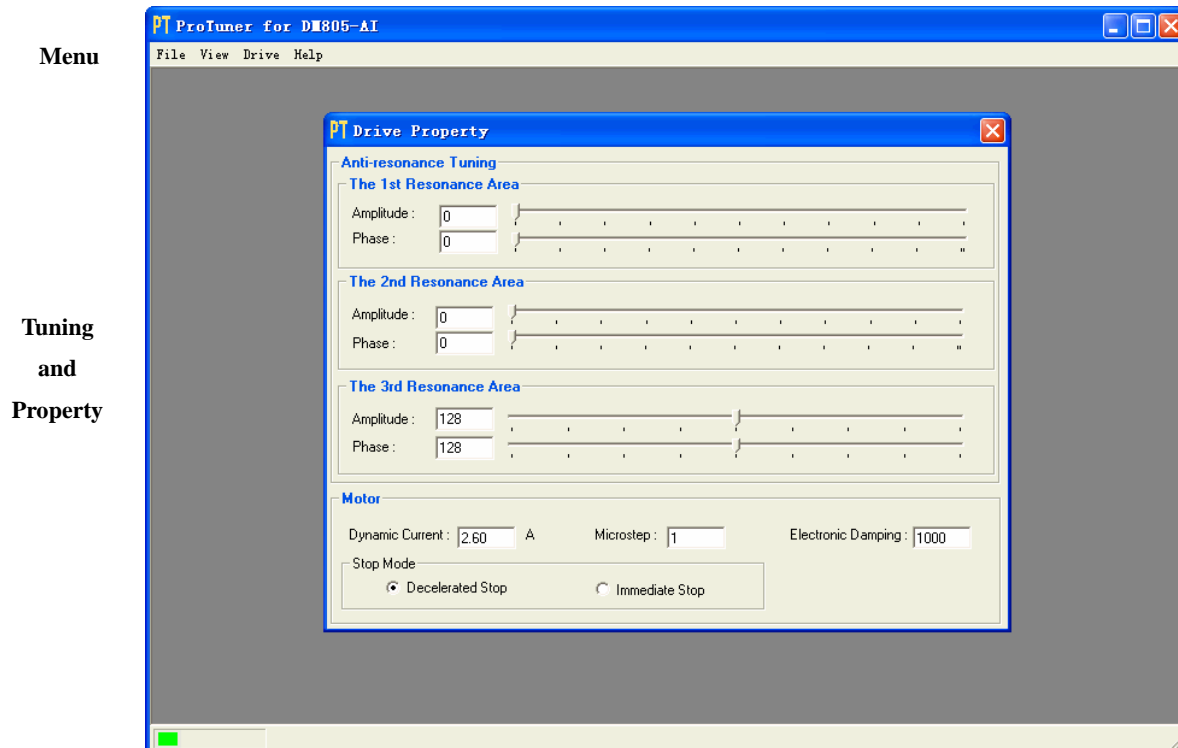

Menus and Toolbar

Menu is at the top of the workspace. You can click menu bar to view the pull-down menu.

| Menu | Pull Down | Function |
|---------|-----------|----------------|
| File -> | Open | Open a file |
| | Save As | Save as a file |
| | Exit | Exit ProTuner |

| Menu | Pull Down | Function |
|---------|-------------------------|--|
| View -> | Error Log | Check the error log |
| | Drive Information | DM805-AI specification |
| Drive-> | Connect to Drive | Connect to drive |
| | Current Loop Tuning | Set current loop parameters Kp and Ki and test. |
| | Property | Set drive properties like I/O logic, motor parameters. |
| | Offset | Check analog and potentiometer offset |
| | Save to Drive | Save all data to drive |
| | Restore Factory Setting | Restore factory setting |
| Help-> | About | Software Information |

Using the Software

Opening a file

If you want to reload the configuration data from a file in the PC, click on the File->Open. The parameters in the software's workspace will be updated

Save as a file

Save the data in current workspace to a file and rename it.

Connecting to Drive Window

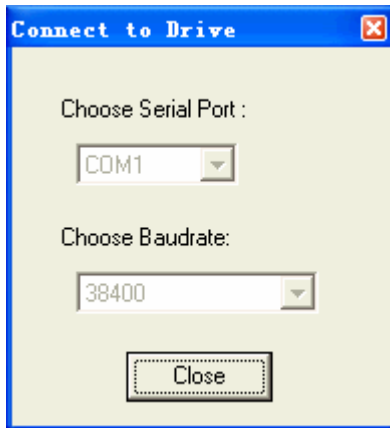

Connect to Drive window appears when you open the software. Choose correct serial port and leave the baud rate as default 38400. The software will try to connect to the drive after you click on the Open button.

Before clicking on the Open button, please make sure:



- 1) The RS232 cable .has been connected between the drive and the PC's serial port.
- 2) The drive has been powered on and the green LED is turned on.

The stepper motor is unnecessary connecting to the drive if you just want to set the parameters but not tuning.



Do not connect or disconnect serial cable when the drive is powered on. The drive's communication circuit may be damaged.

Current loop tuning Window

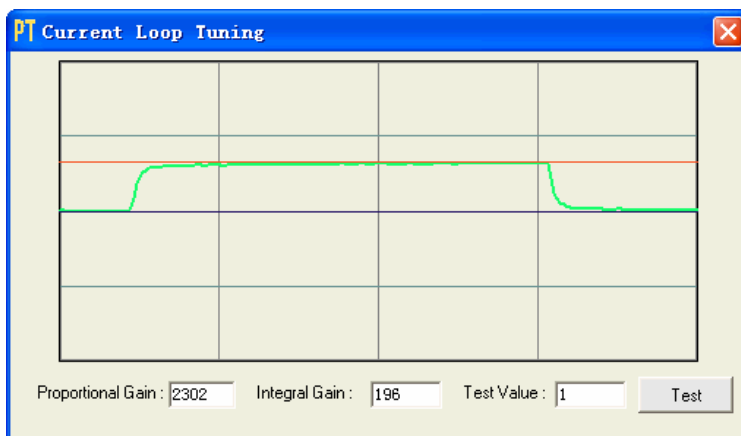

It is used to configure current loop parameters according to different motor. In the tuning window, user can set proportional gain, integral gain and test value.



After finishing the input of the number, don't forget to hit the "Enter" key in the keyboard to confirm new value.

| Item | Description | Range |
|--------------------------|---|-----------|
| Proportional Gain | Increase this parameter to make current rise fast. Proportional Gain determines the response of the driver to current setting command. Low Proportional Gain provides a stable system (doesn't oscillate), has low stiffness, and large current error, causing poor performances in tracking current setting command in each step. Too large Proportional Gain values will cause oscillations and unstable systems. | 1 – 65535 |
| Integral Gain | Adjust this parameter to reduce the steady error. Integral Gain helps the driver to overcome static current errors. A low or zero value for the Integral Gain may have current errors at rest. Increasing the Integral Gain can reduce the error. If the Integral Gain is too large, the systems may "hunt" (oscillate) about the desired position. | 1 – 65535 |
| Test Value | The current amplitude for the step response. | 0.5 – 5 A |
| Test Button | Click this button to activate the test. A target curve (red) and an actual curve (green) will be displayed on the screen for user analysis. | - |

Property Window

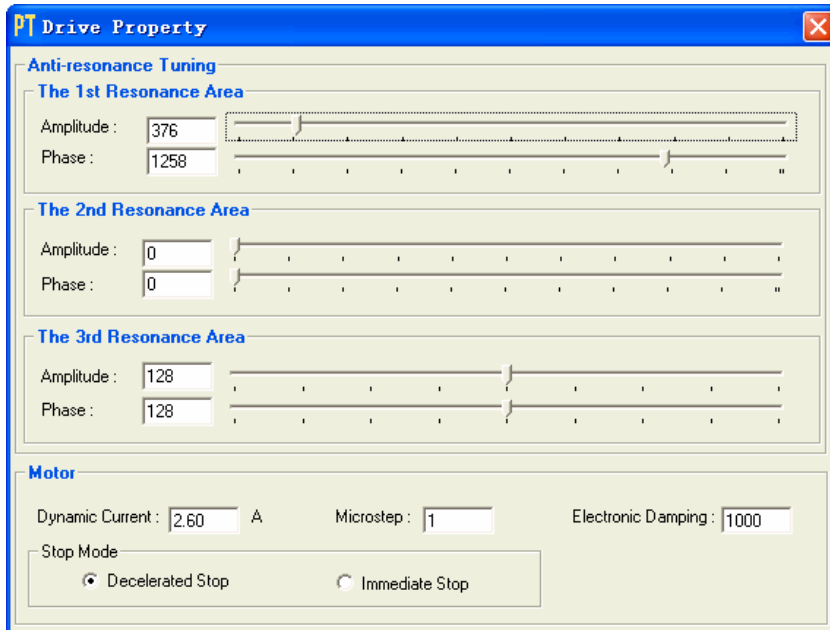

The screenshot shows the 'PT Drive Property' window with the following settings:

- Anti-resonance Tuning**
 - The 1st Resonance Area**: Amplitude: 376, Phase: 1258
 - The 2nd Resonance Area**: Amplitude: 0, Phase: 0
 - The 3rd Resonance Area**: Amplitude: 128, Phase: 128
- Motor**
 - Dynamic Current: 2.60 A
 - Microstep: 1
 - Electronic Damping: 1000
 - Stop Mode: Decelerated Stop, Immediate Stop

The user can set the drive's anti-resonance parameters, output current, microstep, electronic damping and stop mode according the motor and application.



Microstep setting is only effective in Pulse/Direction mode.

| Item | Description | Range |
|-------------------------------|---|-------------------|
| The 1st Resonance Area | It is usually between 0.6 to 1.2 RPS. | - |
| The 2nd Resonance Area | It is usually between 1.2 to 2.4 RPS. | - |
| The 3rd Resonance Area | It is usually between 2.4 to 4.8 RPS. | - |
| Amplitude | Amplitude adjustment for anti-resonance tuning. 0 – 3500 for the 1 st , 2 nd resonance area and 0- 256 for the 3rd resonance area. The user can enter a value directly in the text box or move the slider bar back and forth to get an optimum value. | 0 – 3500 or 0-256 |
| Phase | Phase adjustment for anti-resonance tuning. The user can enter a value directly in the text box or move the slider bar back and forth to get an optimum value. | 0 – 1608 or 0-256 |
| Dynamic Current | Drive's output current setting according to the motor. It should be less than the motor's related current * 1.414. Note: The DIP switch setting must be SW1 = off, SW2 = off, SW3 = off if you want to set this parameter in ProTuner. | 0.5 – 7.0 A |
| MicroStep | Drive's Microstep setting for the motor. Note1: The DIP switch setting must be SW5 = off, SW6 = off, SW7 = off, SW8 = off if you want to set this parameter in ProTuner. Note2: The microstep is effective only in Pulse/Direction mode. | 1 – 512 |
| Electronic Damping | Adjust this parameter to improve the drive's high speed performance. The optimal value depends on the system. | 0 - 6000 |
| Stop Mode | The motor stops immediately when a stop command is applied to the drive if this parameter is immediate stop. Otherwise the motor stops with a acceleration set by the Accel/Ramp or Decel/LoSpeed potentiometers. | - |

Offset

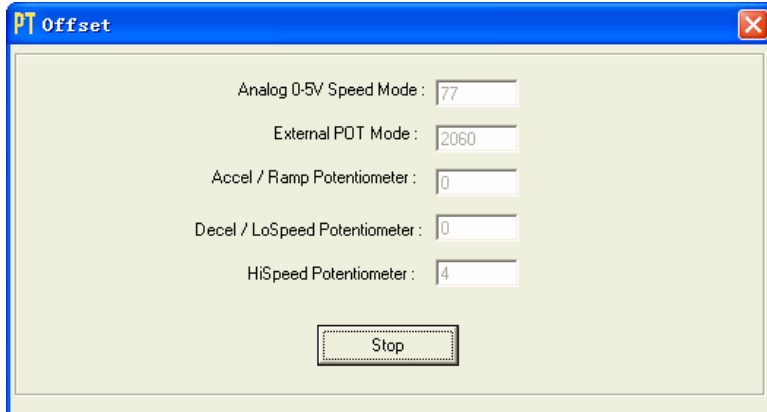

It is used to check the offset of the potentiometers and analog input in factory. The user can ignore it.

Save to Drive

After the drive's configuration and tuning is done, you need to click Drive->Save To Drive to save the data to drive's nonvolatile memory. Otherwise the data will not be lost after power-off.

Restore Factory Setting

This command is used to restore the factory data when the drive is out of control or the user want to do that.

Configuring the drive

If it is the first time setup, you can follow the steps below to configure the drive.

- 1) Set motor related parameters such as dynamic current, microstep and stop mode according to the motor and application.
- 2) Tune the current loop parameters.
- 3) Tune the anti-resonance parameters if necessary.
- 4) Adjust the electronic damping when the high speed performance is not good.



The motor must be connected to the drive before trying to configure the drive.



After finishing the input of the number, don't forget to hit the "Enter" key in the keyboard to confirm new value

Set motor related parameters

Click Drive->Property to open the Property window. You can set the motor's dynamic current, microstep and stop mode.

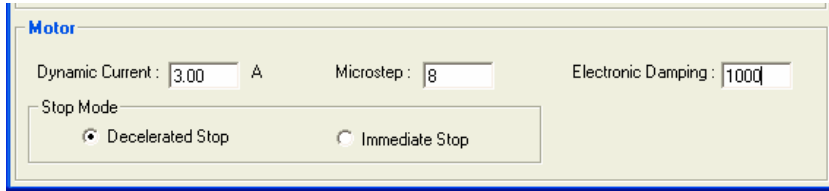

The motor's dynamic current is related to the related current. Usually, the motor manufacturer states the RMS (root mean square) current in datasheet. Please relate to the hardware installation manual for how to set the dynamic current.



The DIP switch setting must be SW1 = off, SW2 = off, SW3 = off if you want to set this parameter in ProTuner.

The microstep is so important is only effective in Pulse and Direction command mode. High resolution microstep makes the motor move more smoothly. Low microstep resolution reduces the high frequency requirement to the controller.



1. The DIP switch setting must be SW5 = off, SW6 = off, SW7 = off, SW8 = off if you want to set this parameter in ProTuner.
2. The microstep is effective only in Pulse/Direction mode.

The motor stops in the acceleration set by the potentiometer. If the application needs fast stop, please click Immediate Stop.

Tune the current loop

The DM805-AI's current loop need to be tuned before normal operation in order to get optimize responses with different motors. Otherwise the motor will be easily stall or howls when power-up. Below is the tuning process for a NEMA 23 motor with 24VDC supply voltage.

Step 1: Set **Test Value** 1 and start the tuning with small **Proportional Gain** and “zero” **Integral Gain**. Here we set **Proportional Gain** 500.

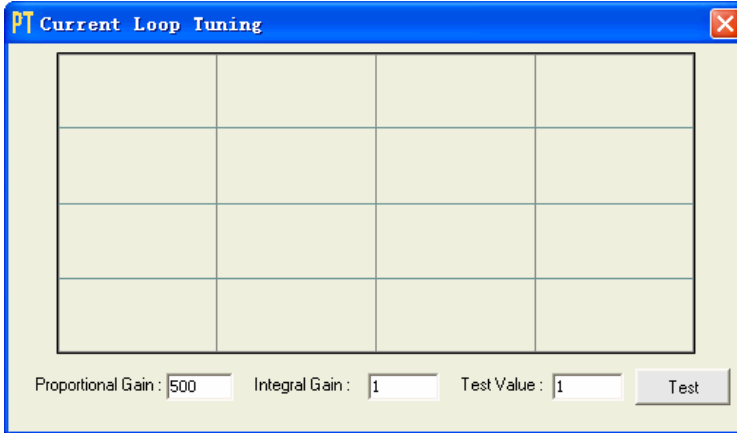

Initial Value

Proportional Gain = 500

Integral Gain = 1

Step 2: Click the **Test** button and the plot window will show two curves. The red one is target current and the green one is actual current. There is large gap between them in the scope. It indicates that a large **Proportional Gain** needs to be introduced.

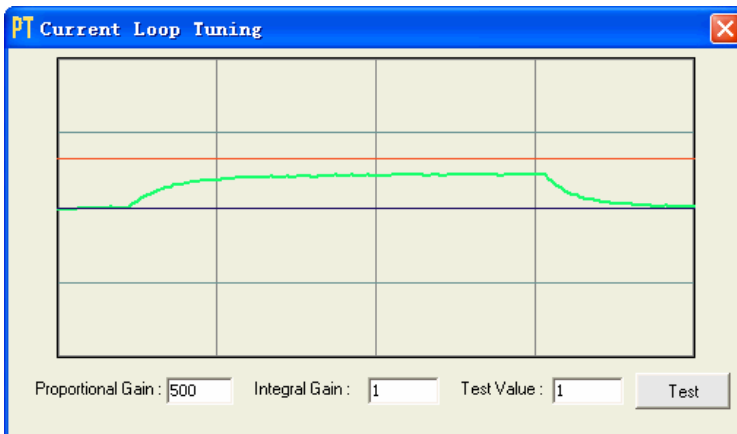

Start Test:

Proportional Gain = 500

Integral Gain = 1

Step 3: Increase **Proportional Gain** to 1000 and click **Start**. The gap between target value and actual value is smaller but a higher **Proportional Gain** is still needed.

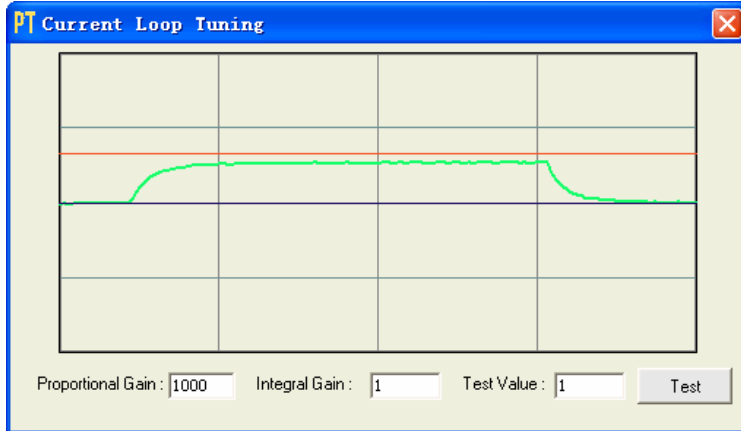

↑ Proportional Gain:
Proportional Gain = 1000
Integral Gain = 0

Step 3: Give **Proportional Gain** 2000, 3000, 4000 and click **Test button**, respectively. The green curve is getting more and more close to the red curve. Over-shoot is obvious when we increase **Proportional Gain** to 4000. It indicates that you need to stop increasing K_p and back off. Our purpose is to make the green curve (the actual current) a little higher than the red curve (the target). So we decrease K_p to 3700 until the actual value is exactly over the target value.

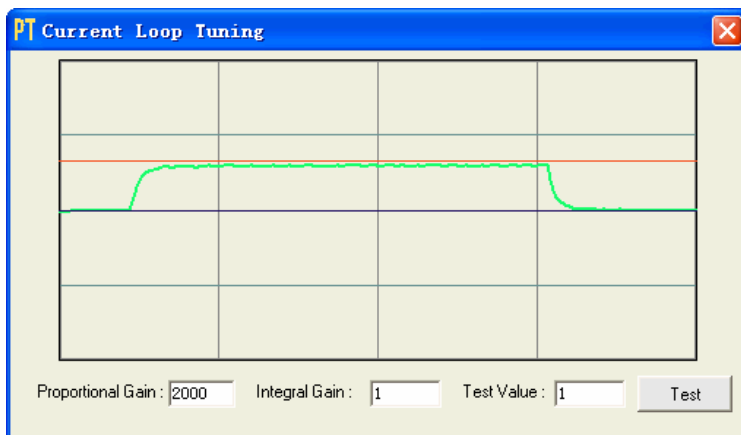

↑ Proportional Gain:
Proportional Gain =2000
Integral Gain = 1

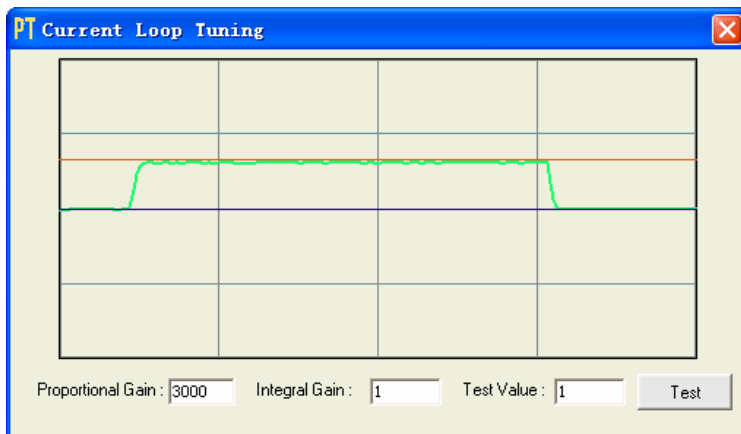

↑ Proportional Gain:
Proportional Gain =3000
Integral Gain = 1

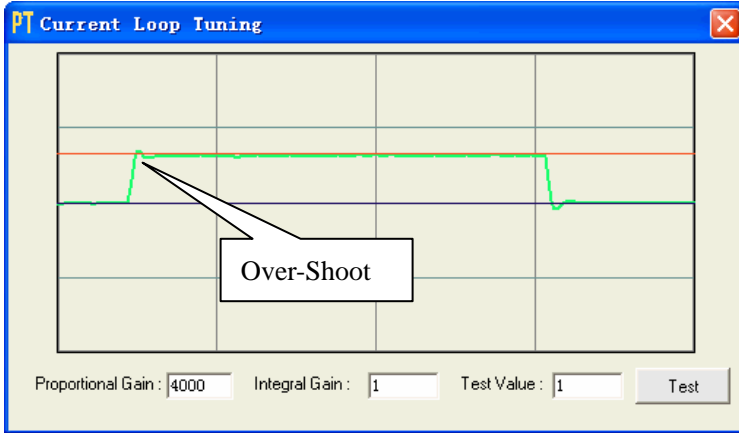

↑ Proportional Gain:
Proportional Gain =4000
Integral Gain = 1

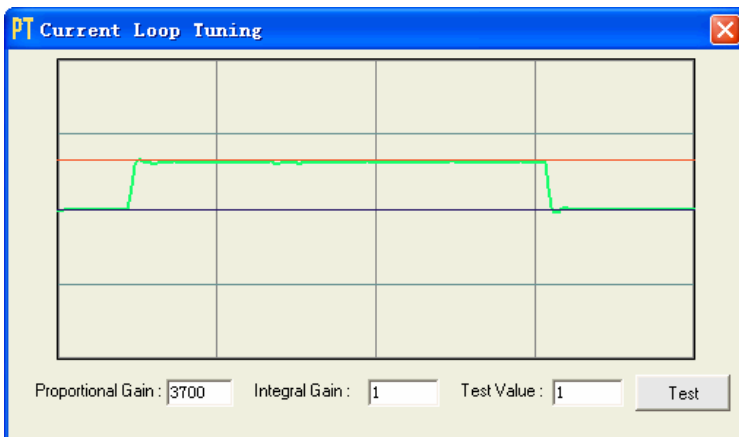

↓ Proportional Gain:
Proportional Gain =3700
Integral Gain = 1

Step 4: Now the **Proportional Gain** is relatively good enough. But there is still gap between the green curve and the red curve when we use the mouse to zoom in the green curve. So we need to introduce **Integral Gain** to reduce the “gap” or steady error at the constant part. It follows the same procedure as **Proportional Gain**. High **Integral Gain** causes big vibration, system lag and makes the performance worse. The following figures show how to tune the integral gain.

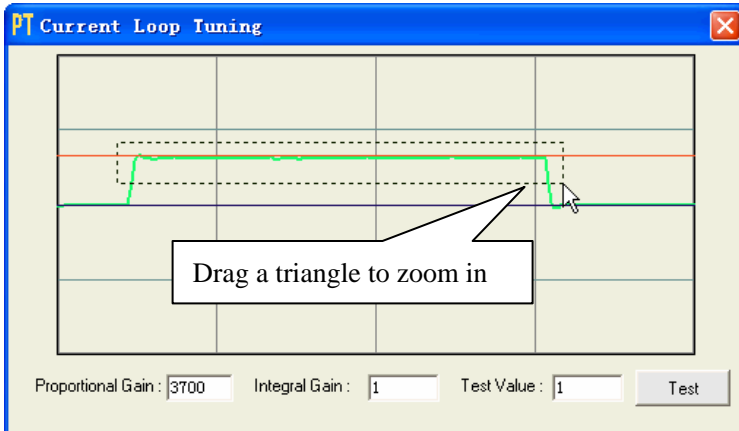

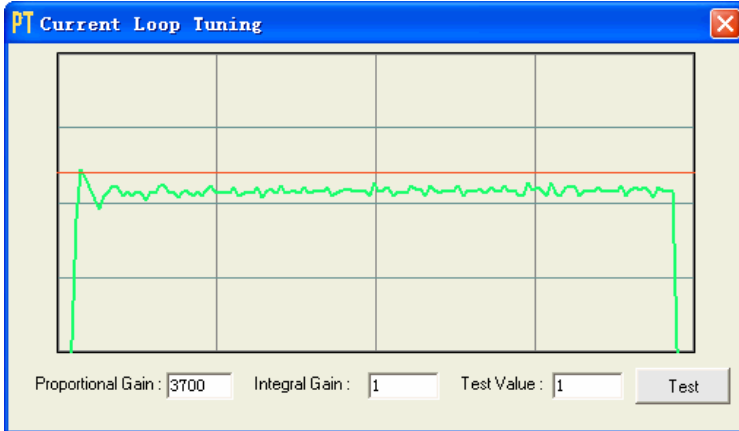

Zero Integral Gain:

Proportional Gain =3700

Integral Gain = 1

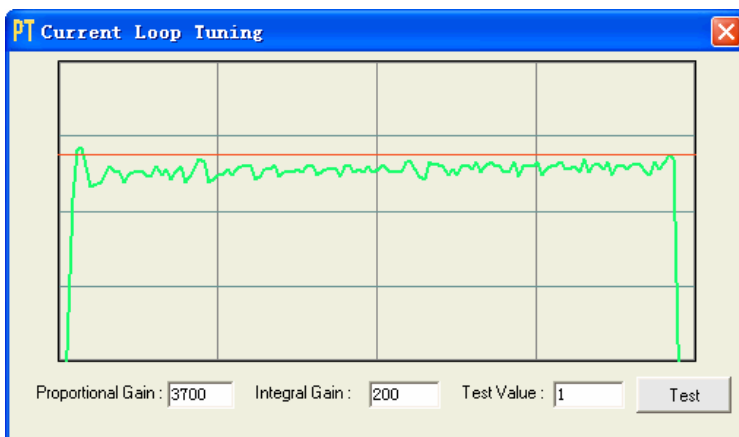

↑ Integral Gain:

Proportional Gain =3700

Integral Gain = 200



↑ Integral Gain:

Proportional Gain =3700

Integral Gain = 400

Step 5: The current loop tuning is basically finished. You can continue to adjust K_p and K_i for better performance. Now the updated K_p and K_i is just stored in the driver's RAM. They will be lost when we power off the driver. **Don't forget to click Drive->Save To Drive to store the changed value to the drive's EEPROM.**

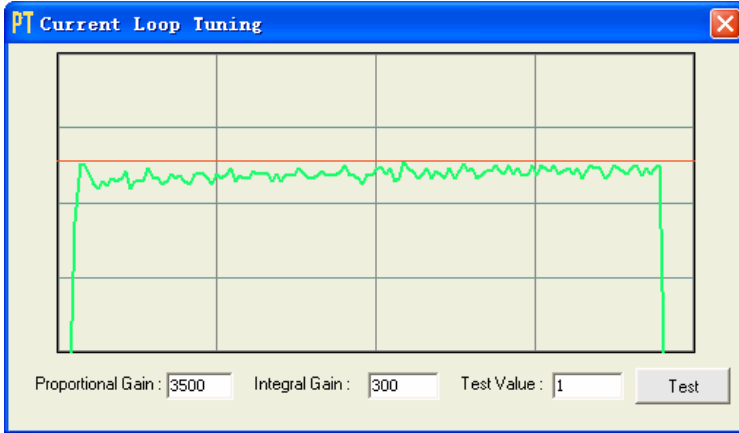

Further Adjustment:
Proportional Gain = 3500
Integral Gain = 300

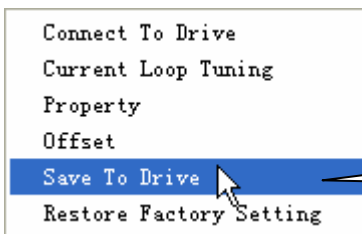

Save all the changes to the drive's non-violated nonvolatile memory.

Anti-resonance Tuning

Step motors are highly resonant, which results in vibration and ringing. The ringing utilizes a large fraction of the motor's available torque – thereby wasting performance. Furthermore, at mid-range velocities, the resonance can become so severe that the motor loses synchronization and stalls. The DM442 drive provides robust anti-resonance control to stop the vibrations and maintain equilibrium. This feature requires that the drive be configured with respect to the total inertia in the system. If set improperly, the effectiveness of the feature may be diminished.



1. For most of the application, it is not needed to tune DM805-AI's anti-resonance parameters. We only recommend the advance user to use this function as it is a boring process.
2. In most of the case, only the tuning of the 1st and 2nd anti-resonance area has obvious effect.

Step 1: Connect the drive as follows and configure it in Low/High Speed mode by set SW7 = OFF and SW8 = ON. As the Speed input is connected to Signal GND, the motor speed is determined by the LoSpeed potentiometer and it can be adjusted from 0RPS to 5RPS.

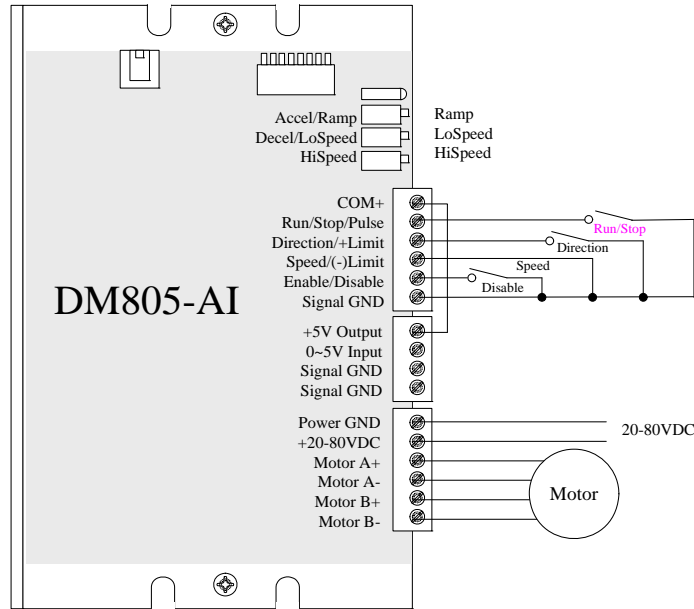

Step 2: Start to move the motor by activating the Run/Stop input. Find a resonance speed by slightly adjusting the LoSpeed parameter CW and CCW.

Step 3: Keep the motor running at the resonance speed and verify the motor smoothness. You may find a better smoothing value by slightly moving the slider bars of **Amplitude** and **Phase** back and forth. If the motor speed is 0.6-1.2RPS, you should tune the Amplitude and Phase at the 1st resonance area. The 2nd resonance area is 1.2-2.4 RPS and the 3rd resonance area is 2.4 4.8 RPS.



1. You can calculate the motor speed roughly as follows:

$$Speed(RPS) = 5 \pm 0.01(RPS) \times \frac{\text{Turns of LoSpeed Potentiometer}}{25\text{Turns}}$$

2. It is very important to make the **Amplitude** and **Phase** adjustments at the resonance speed.

For example, we find a resonance speed at 0.98 RPS. We begin to move the Amp1 slider forth and the motor vibration and noise became lower and lower. Finally we find the move is the smoothest when **Amplitude** is 3300. The motor vibration and noise increase if **Amplitude** exceeds 3300. Then we follow the same procedure to search the best point for **Phase**. See Figure 26. Anti-resonance tuning is done.

Step 4: Click **Drive->Save To Drive** to save all the parameters to DM805-AI.

Adjusting the Electronic Damping

The factory setting for the electronic damping is 1000. If the motor is easily stalled and generates odd noise at middle speed, you can try other values such as 500, 1500, 2000, 2500.

Contact Us

China Headquarters

Address: 3/F, Block 2, Nanyou Tianan Industrial Park, Nanshan District Shenzhen, China

Web: <http://www.leadshine.com>

Sales Hot Line:

Tel: 86-755-2641-7674 (for Asia, Australia, Africa areas)

86-755-2640-9254 (for Europe areas)

86-755-2641-7617 (for Europe areas)

Fax: 86-755-2640-2718

Email: sales@leadshine.com.

Technical Support:

Tel: 86-755-2641-8447, 86-755-2641-8774, 86-755-2641-0546

Fax: 86-755-2640-2718

Email: tech@leadshine.com(for All)

Leadshine U.S.A

Address: 25 Mauchly, Suite 318 Irvine, California 92618

Tel: 1-949-608-7270

Fax: 1-949-608-7298

Web: <http://www.leadshineUSA.com>

Email: sales@leadshineUSA.com and support@leadshineUSA.com.